

OGL 081 N3K-TSSL

Angled Light Barrier

- Metal casing
- All-purpose mounting
- Optical axis approachable in x-, y- and z-direction
- Integrated electronic module
- Sensitivity adjustable
- High operating frequency
- Light/dark switching
- Bright ring LED
- 5-year warranty

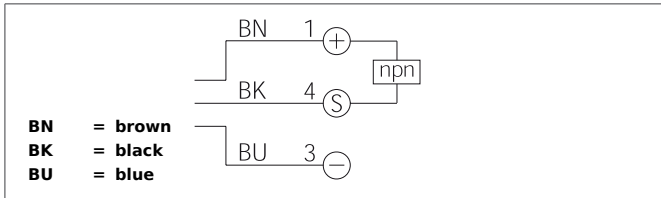

Safety instructions

The Instruments are not to be used for safety applications, in particular applications in which safety of persons depends on proper operation of the instruments.
 These instruments shall exclusively be used by qualified personnel.

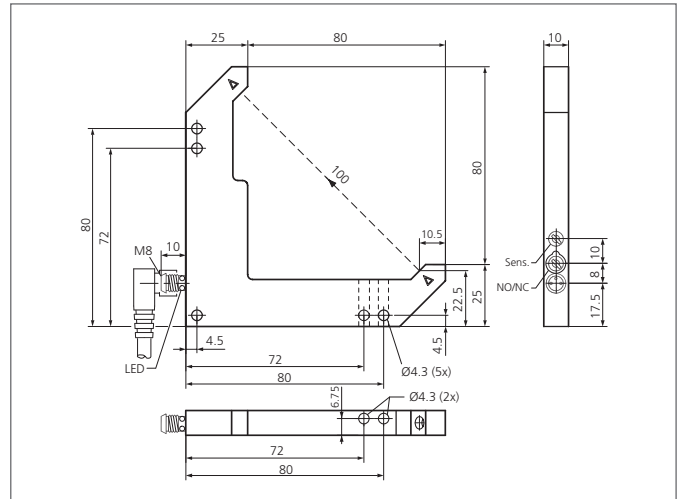

TECHNICAL INFORMATION (typ.)	+20°C, 24V DC
Operating principle	Optical
Evaluation	digital
Size	105 x 105 x 10 mm (Dimensions)
Design	Angle
Branch length	80/80 mm
Emitted light	Red, 660 nm, clocked
Service voltage	10 ... 35 V DC (Supply Class 2)
Internal power consumption	< 30 mA
Operating distance	100 mm (optical axis)
Resolution	Ø 0,7 mm
Sensitivity adjustment	potentiometer
Switching output	npn, 200 mA, NO/NC, switchable
Switching hysteresis	< 0,25 mm
Voltage drop	< 2,8 V
Switching frequency	4.000 Hz
Reproducibility	0,06 mm
Ambient temperature	-10 ... +60 °C
Ambient light immunity	70 kLx
Insulation voltage endurance	500 V
Protection class	IP 67
Protection degree	III, operation on protective low voltage
Casing material	Die-cast zinc black lacquered finish
Connection	Connector, M8, 3-poled

OGL 081 N3K-TSSL
Angled Light Barrier



TECHNICAL INFORMATION (typ.)

+20°C, 24V DC

Connecting cable

TK ...